

YOUR SIGNATURE IS REQUIRED FOR APPROVAL BEFORE ANY RELEASE OF PRODUCTION DRAWINGS

TOLERANCES

CUTOUTS +/- 1/16

OVERALL FOAM THICKNESS & CAVITY DEPTHS +/- 1/8

SIGNATURE

DATE

LID TRAY - ELEVATION

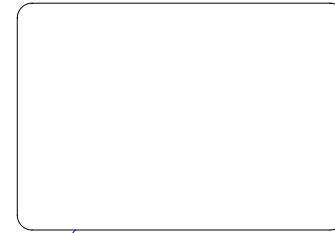
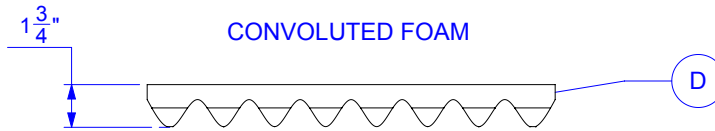

CUSTOM LID

BASE TRAY

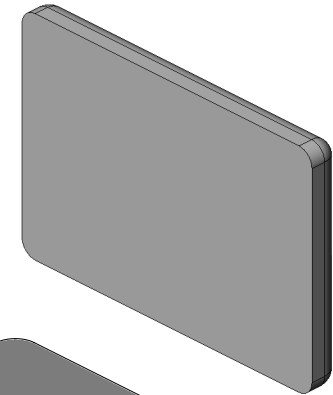
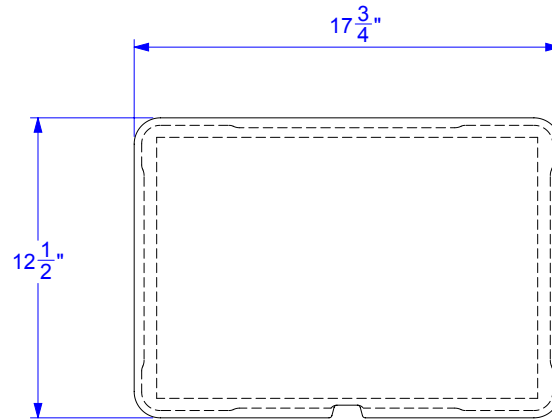

OPTIONAL LAYER (COVERS PANEL FLANGE)

BASE TRAY - ELEVATION

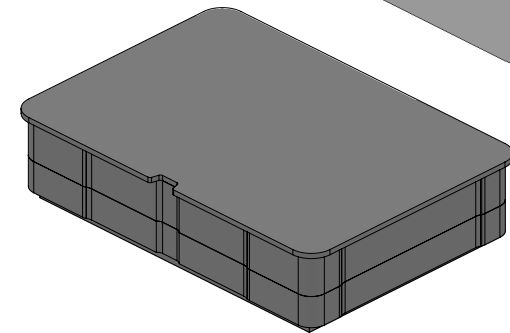
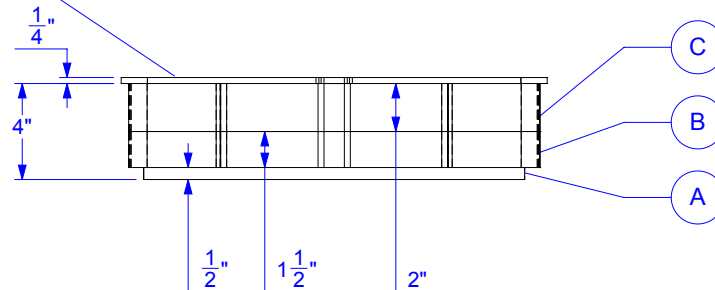

FOAM DENSITY MAY VARY. DIMENSIONS ARE IN INCHES UNLESS OTHERWISE SPECIFIED

YOUR SIGNATURE IS REQUIRED FOR APPROVAL BEFORE ANY RELEASE OF PRODUCTION DRAWINGS

TOLERANCES

CUTOUTS +/- 1/16

OVERALL FOAM THICKNESS & CAVITY DEPTHS +/- 1/8

SIGNATURE

DATE

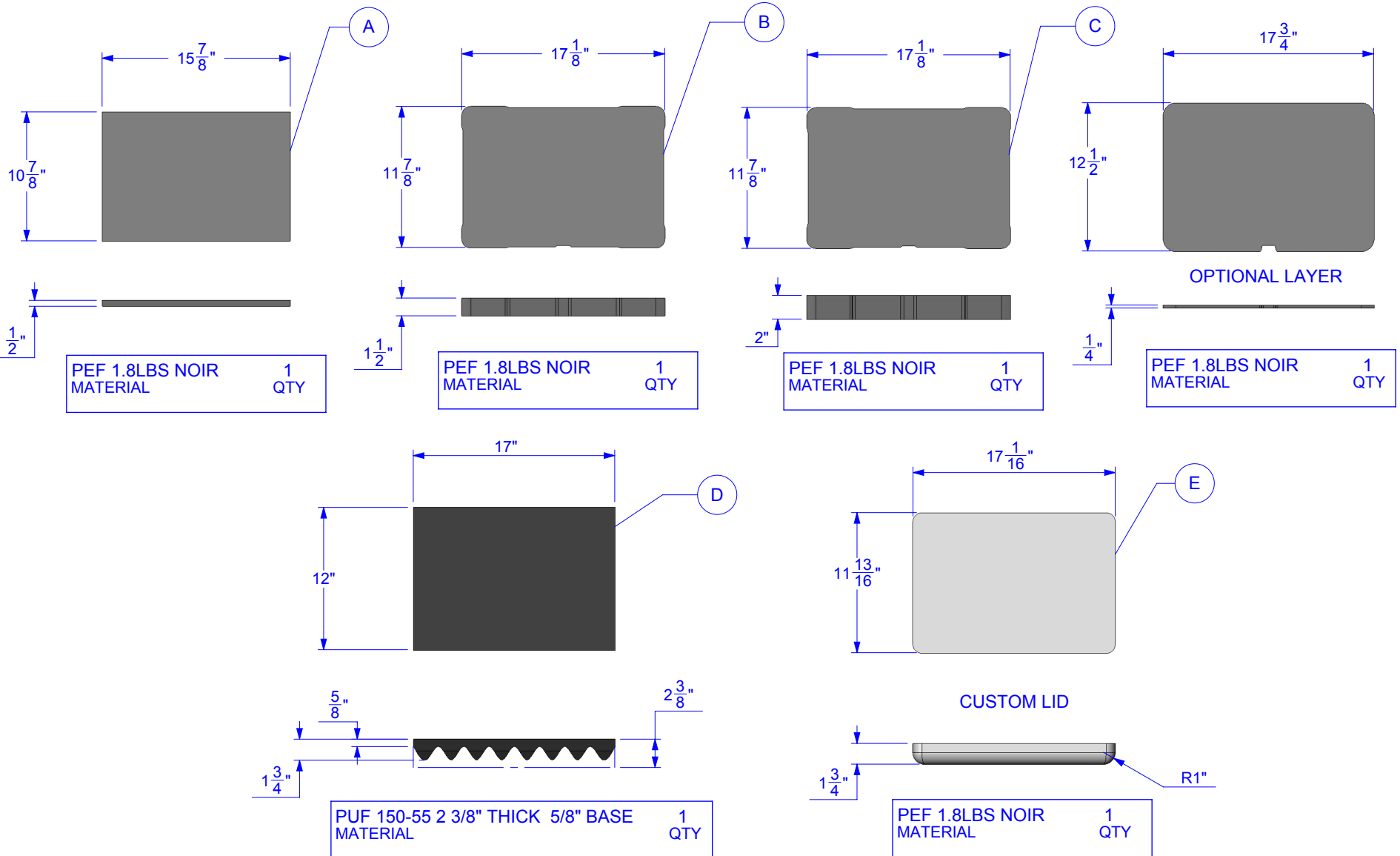

FOAM DENSITY MAY VARY. DIMENSIONS ARE IN INCHES UNLESS OTHERWISE SPECIFIED